

描述 / Descriptions

SOT-323 塑封封装 硅半导体二极管。Silicon Diode in a SOT-323 Plastic Package.

特征 / Features

体积小，采用 SMD 封装，开关速度快，连续反向电压和重复峰值电压高、正向峰值电流大。

Very small plastic SMD package, High switching speed, High Continuous reverse and Repetitive peak reverse voltage, High Repetitive peak forward current.

用途 / Applications

用于快速开关转换，表面安装电路。

Applications for High-speed switching., surface mounted circuits.

内部等效电路 / Equivalent Circuit

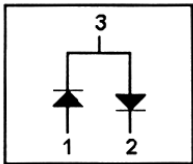

引脚排列 / Pinning



PIN: See Equivalent Circuit.

印章代码 / Marking

Marking	HA7
---------	-----

极限参数 / Absolute Maximum Ratings(Ta=25°C)

参数 Parameter	符号 Symbol	数值 Rating	单位 Unit
Repetitive Reverse Voltage	V_{RRM}	85	V
Continuous reverse voltage	V_R	75	V
Continuous forward current	$I_{F(1)}$	150	mA
	$I_{F(2)}$	130	mA
Repetitive peak forward current	I_{FRM}	500	mA
Non-repetitive Peak Forward Current	$I_{FSM(1)(t=1\text{ S})}$	0.5	A
	$I_{FSM(2)(t=1\text{ mS})}$	1.0	A
	$I_{FSM(3)(t=1\mu\text{S})}$	4.0	A
Power Dissipation	P_D	200	mW
Junction Temperature	T_j	150	°C
Storage Temperature Range	T_{stg}	-55~+150	°C

电性能参数 / Electrical Characteristics(Ta=25°C)

参数 Parameter	符号 Symbol	测试条件 Test Conditions	最小值 Min	典型值 Typ	最大值 Max	单位 Unit
Forward Voltage	V_F	$I_F=1\text{mA}$			715	mV
		$I_F=10\text{mA}$			855	mV
		$I_F=50\text{mA}$			1	V
		$I_F=150\text{mA}$			1.25	V
Instantaneous Reverse Current Total Capacitance	I_R	$V_R=25\text{V}$			30	nA
		$V_R=75\text{V}$			1	μA
		$V_R=25\text{V}$ $T_j=150^\circ\text{C}$			30	μA
		$V_R=75\text{V}$ $T_j=150^\circ\text{C}$			50	μA
Diode capacitance	C_d	$V_R=0$ $f=1\text{MHz}$			1.5	pF
Reverse Recovery Time	t_{rr}	$I_R=1\text{mA}$ $R_L=100\Omega$ $I_F=1_R=10\text{mA}$			4	ns
Forward recovery voltage	V_{fr}	$I_F=10\text{mA}$ $t_r=20\text{ns}$			1.75	V

电参数曲线图 / Electrical Characteristic Curve

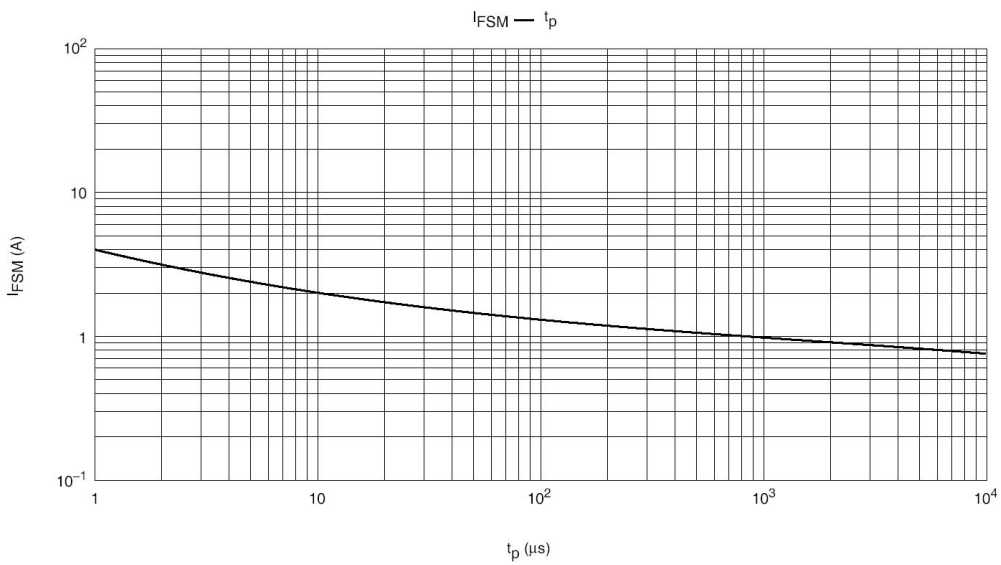
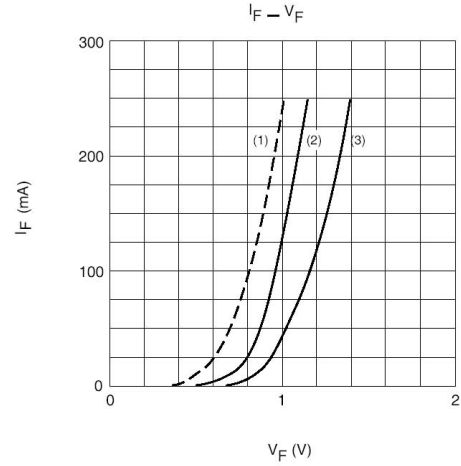
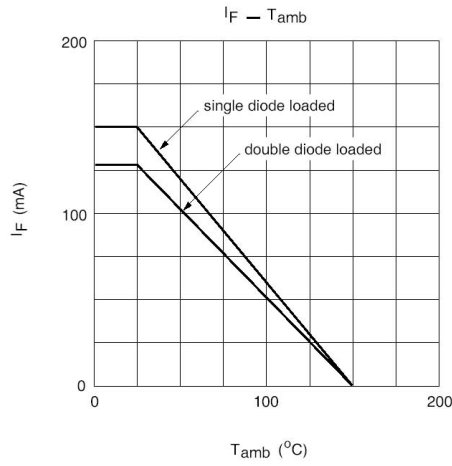
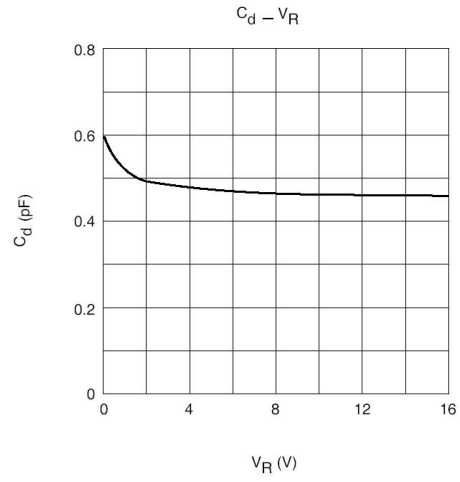
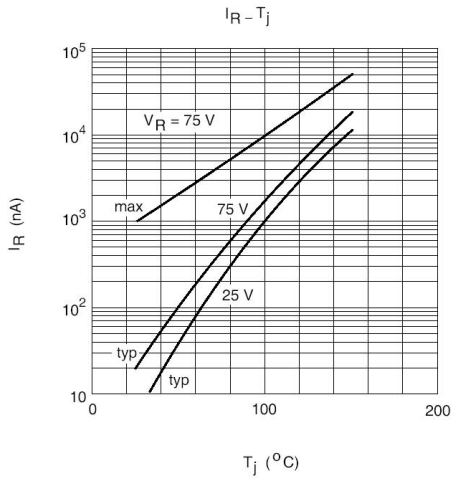

外形尺寸图 / Package Dimensions

SOT-323

单位: mm

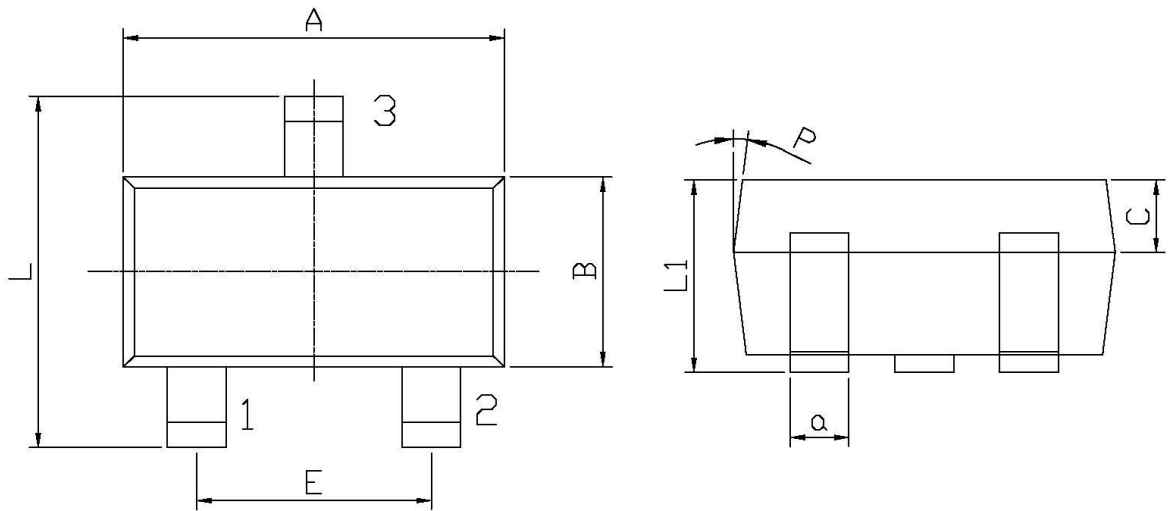

Symbol	Dimensions In Millimeters		Symbol	Dimensions In Millimeters	
	Min	Max		Min	Max
A	1.95	2.35	C	0.30	0.50
L	2.00	2.2	L1	0.85	1.15
E	1.20	1.40	α	0.20	0.40
B	1.15	1.35	P	7°	

印章说明 / Marking Instructions

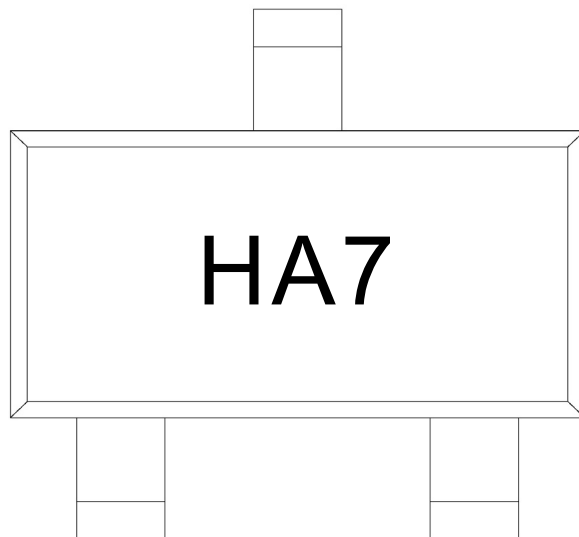

说明：

H： 为公司代码

A7： 为型号代码

Note:

H: Company Code.

A7: Product Type.

回流焊温度曲线图(无铅) / Temperature Profile for IR Reflow Soldering(Pb-Free)



说明：

- 1、预热温度 25 ~ 150°C，时间 60 ~ 90sec;
- 2、峰值温度 245±5°C，时间持续为 5±0.5sec;
- 3、焊接制程冷却速度为 2 ~ 10°C/sec.

Note:

- 1.Preheating:25~150°C, Time:60~90sec.
- 2.Peak Temp.:245±5°C, Duration:5±0.5sec.
3. Cooling Speed: 2~10°C/sec.

耐焊接热试验条件 / Resistance to Soldering Heat Test Conditions

温度：260±5°C

时间：10±1 sec.

Temp.:260±5°C

Time:10±1 sec

包装规格 / Packaging SPEC.

卷盘包装 / REEL

Package Type 封装形式	Units 包装数量					Dimension 包装尺寸 (unit: mm ³)		
	Units/Reel 只/卷盘	Reels/Inner Box 卷盘/盒	Units/Inner Box 只/盒	Inner Boxes/Outer Box 盒/箱	Units/Outer Box 只/箱	Reel	Inner Box 盒	Outer Box 箱
SOT-323	3,000	10	30,000	6	180,000	7" ×8	180×120×180	390×385×205

使用说明 / Notices