

BRBT1208SWBD

Rev.A Apr.-2024

描述 / Descriptions

TO-263 塑封封装 双向可控硅。

Triac in a TO-263 Plastic Package.

特征 / Features

中电流可控硅，低通态压降，高可靠性和稳定性，热敏电阻特性低，无卤产品。

Medium current triac, Low on state voltage drop, High reliability and stability, Low thermal resistance, HF Product.

用途 / Applications

适用于一般用途交流开关。如固态继电器、加热调节、异步电动机起动电路、电机速度控制器等。

Suitable for general purpose AC switching .Such as static relays, heating regulation, induction motor starting circuits, motor speed controllers, etc.

内部等效电路 / Equivalent Circuit

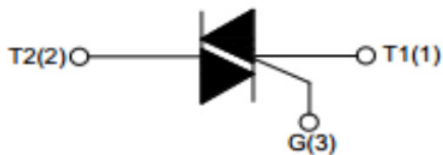

引脚排列 / Pinning

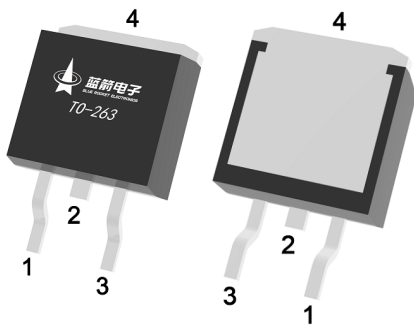

PIN1 : Main Terminal 1 PIN 2、 4 : Main Terminal 2 PIN 3: Gate

印章代码 / Marking

见印章说明。

See Marking Instructions.

极限参数 / Absolute Maximum Ratings(Ta=25°C)

参数 Parameter	符号 Symbol	数值 Rating	单位 Unit
Repetitive peak off-state/reverse voltages(T _j =125°C)	V _{DRM} /V _{RPM}	800	V
RMS on-state current(T _C =90°C)	I _{T(RMS)}	12	A
Non repetitive surge peak on-state current(full cycle, T _j =25°C)	I _{TSM(t=20ms)}	120	A
I ² t value for fusing(T _j =25°C)	I ² t _(tp=10ms)	78	A ² s
Critical rate of rise of on-state current (I _G =2I _{GT} , f=120Hz T _j =125°C)	dI/dt I-II-III	50	A/μs
Peak gate current(t _p =20μs T _j =125°C)	I _{GM}	4.0	A
Average gate power dissipation(T _j =125°C)	P _{G(AV)}	1	W
Operating junction temperature range	T _j	-40~125	°C
Storage junction temperature range	T _{stg}	-40~150	°C
Junction to ambient(AC)	R _{th(j-a)}	45	°C/W
Junction to case for(AC)	R _{th(j-c)}	1.4	

电性能参数 / Electrical Characteristics(T_j=25°C)
免缓冲器和逻辑电平 (3象限) / Snubberless and logic level (3 quadrants)

符号 Symbol	测试条件 Test Conditions	信号区 Quadrant	数值 Value		单位 Unit
I _{GT}	V _D =12V R _L =30Ω	I-II-III	Max.	10	mA
V _{GT}	V _D =12V R _L =30Ω	I-II-III	Max.	1.3	V
V _{GD}	V _D =V _{DRM} R _L =3.3KΩ T _j =125°C	I-II-III	Min.	0.2	V
I _L	I _G =1.2I _{GT}	I-III	Max.	25	mA
		II		30	
I _H	I _T =100mA		Max.	15	mA
(dV/dt)	V _D =67% V _{DRM} Gate Open	T _j =125°C	Min.	40	V/μs
V _{TM}	I _{TM} =17A t _p =380μs	T _j =25°C	Max.	1.55	V
I _{DRM}	V _D =V _{DRM} V _R =V _{RPM}	T _j =25°C		10	μA
I _{RPM}		T _j =125°C		1	mA

电参数曲线图 / Electrical Characteristic Curve

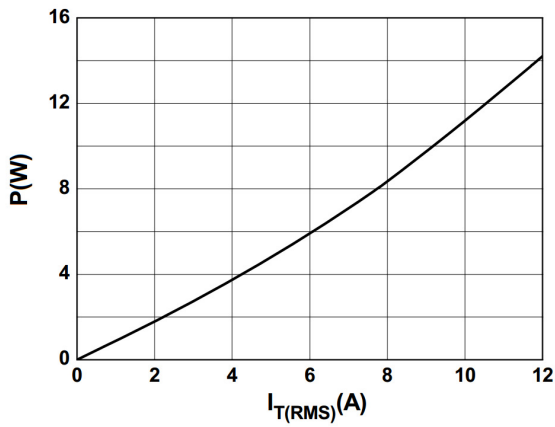

FIG.1 Maximum power dissipation versus RMS on-state current

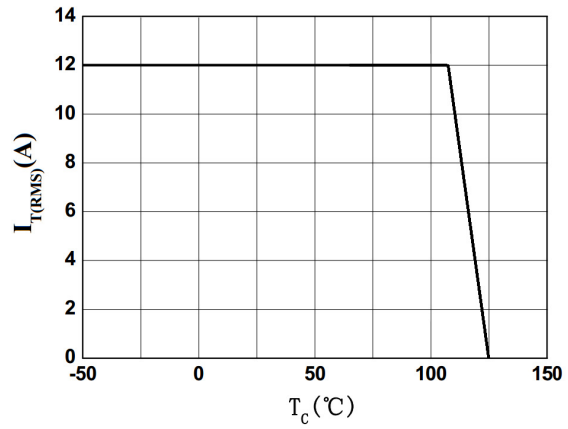

FIG.2: RMS on-state current versus case temperature

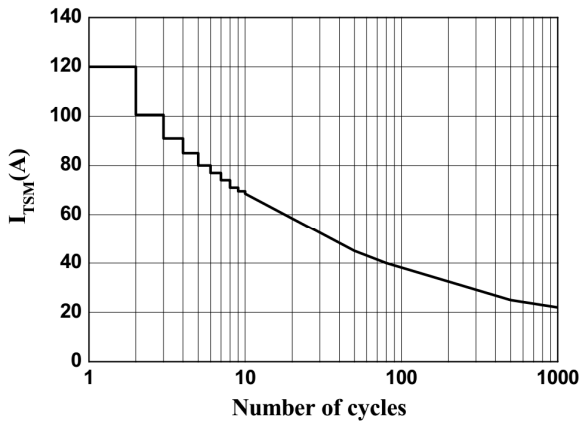

FIG.3: Surge peak on-state current versus number of cycles

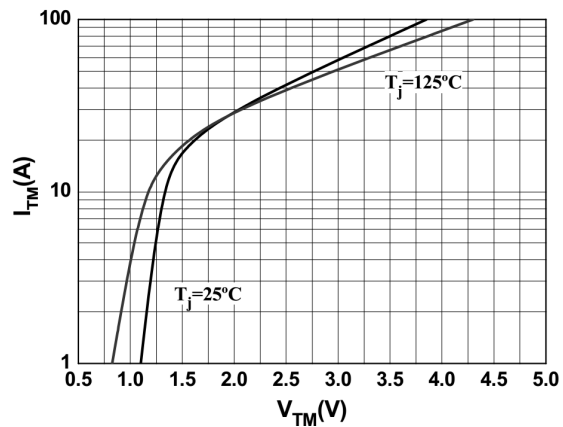

FIG.4: On-state characteristics

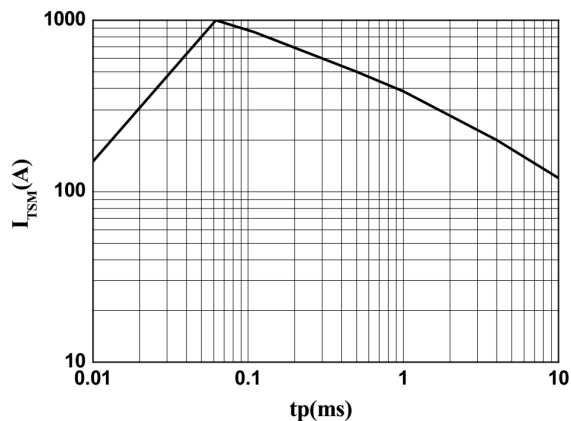

FIG.5: Non-repetitive surge peak on-state current for a sinusoidal pulse with width $t_p < 20\text{ms}$, and corresponding value of I_2t ($di/dt < 50\text{A}/\mu\text{s}$)

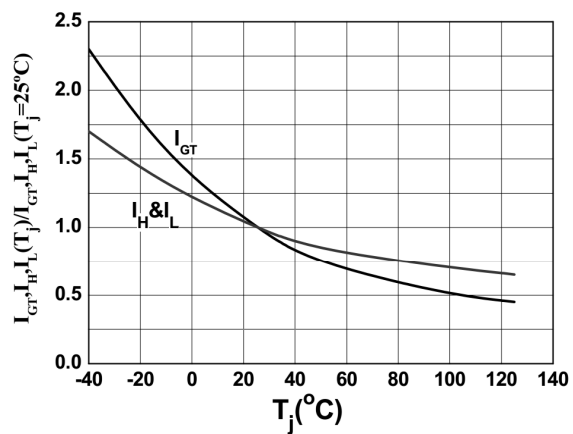
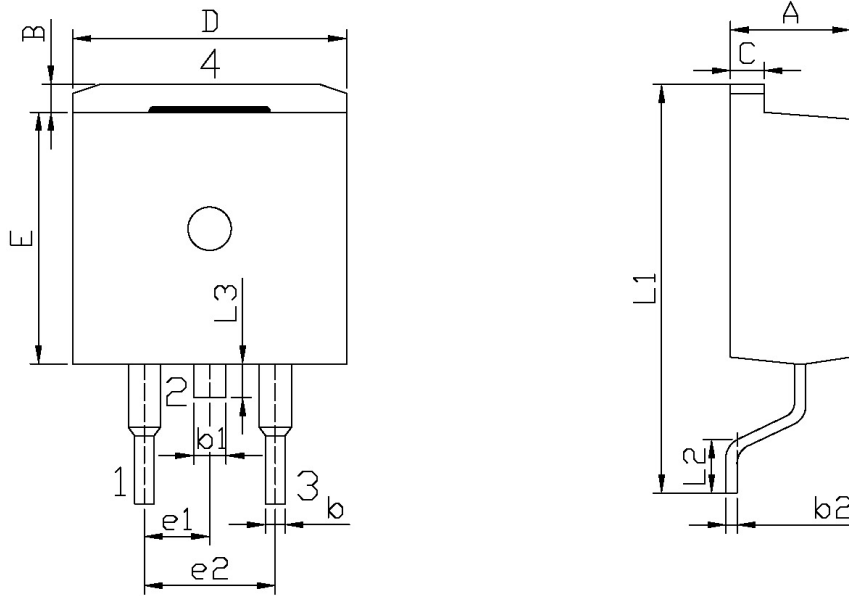

FIG.6: Relative variations of gate trigger current, holding current and latching current versus junction temperature

外形尺寸图 / Package Dimensions



单位: mm

Symbol	Dimensions In Millimeters		Symbol	Dimensions In Millimeters	
	Min	Max		Min	Max
A	4.30	4.70	E	9.00	9.40
B	1.00	1.40	e1	2.34	2.74
b	0.70	0.90	e2	4.88	5.28
b1	1.15	1.35	L1	15.00	16.00
b2	0.40	0.60	L2	2.24	2.84
C	1.20	1.40	L3	1.20	1.60
D	9.80	10.20			

TQ-263

印章说明 / Marking Instructions

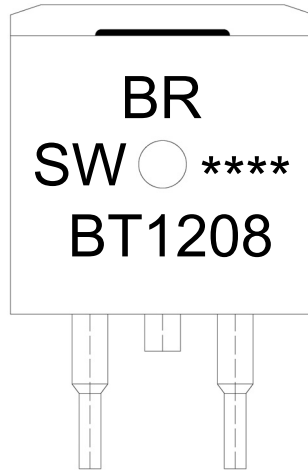

说明：

BR： 为公司代码

SW： 为 I_{GT} 分档代码

****： 为生产批号代码，随生产批号变化

BT1208： 为型号代码

Note:

BR: Company Code

SW: I_{GT} Bracket code

****: Lot No. Code, code change with Lot No

BT1208: Product Type Code

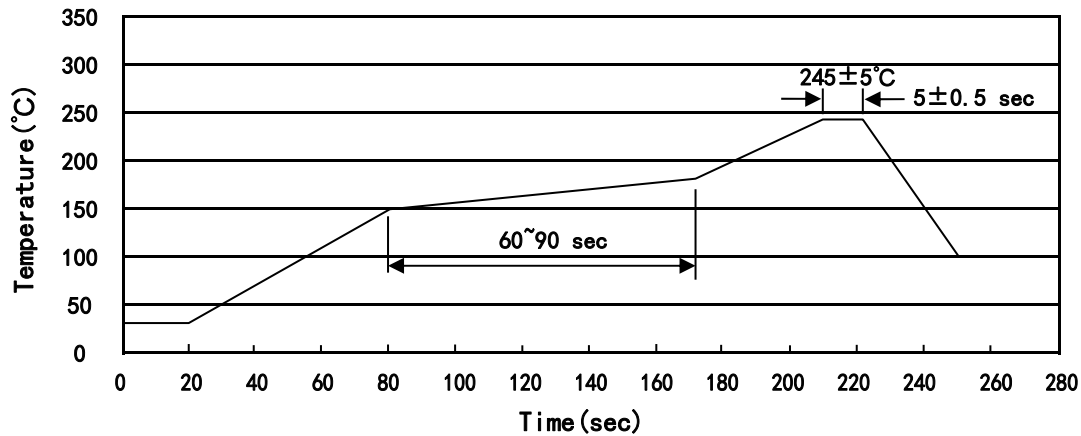
回流焊温度曲线图(无铅) / Temperature Profile for IR Reflow Soldering(Pb-Free)

说明：

- 1、预热温度 150~180°C，时间 60~90sec;
- 2、峰值温度 245±5°C，时间持续为 5±0.5sec;
- 3、焊接制程冷却速度为 2~10°C/sec.

Note:

- 1.Preheating:150~180°C, Time:60~90sec.
- 2.Peak Temp.:245±5°C, Duration:5±0.5sec.
3. Cooling Speed: 2~10°C/sec.

耐焊接热试验条件 / Resistance to Soldering Heat Test Conditions

温度：260±5°C

时间：10±1 sec.

Temp.:260±5°C

Time:10±1 sec

包装规格 / Packaging SPEC.

卷盘包装 / REEL

Package Type 封装形式	Units 包装数量					Dimension 包装尺寸 (unit: mm ³)		
	Units/Reel 只/卷盘	Reels/Inner Box 卷盘/盒	Units/Inner Box 只/盒	Inner Boxes/Outer Box 盒/箱	Units/Outer Box 只/箱	Reel	Inner Box 盒	Outer Box 箱
TO-263	800	1	800	6	4,800	13" ×24	360×360×50	380×335×366

套管包装 / TUBE

Package Type 封装形式	Units 包装数量					Dimension 包装尺寸 (unit: mm ³)		
	Units/Tube 只/套管	Tubes/Inner Box 套管/盒	Units/Inner Box 只/盒	Inner Boxes/Outer Box 盒/箱	Units/Outer Box 只/箱	Tube 套管	Inner Box 盒	Outer Box 箱
TO-263	50	20	1,000	5	5,000	532×33×7.0	555×164×50	575×290×180

使用说明 / Notices