

**BRD630**  
Rev.F Dec.-2024

**描述 / Descriptions**

N 沟道 TO-252 塑封封装场效应管。  
N-Channel MOSFET in a TO-252 Plastic Package.

**特征 / Features**

$V_{DS}=200V$  ;  $I_D=9A$  ;  $V_{GS}=\pm 20V$   
 $R_{DS(on)}@10V \leq 0.4\Omega$  (Type.0.35 $\Omega$ )  
无卤产品。HF Product.

**用途 / Applications**

网络、负载开关、LED 应用。  
Networking, Load Switch, LED applications.

**内部等效电路 / Equivalent Circuit**

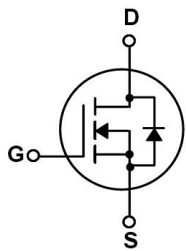

**引脚排列 / Pinning**

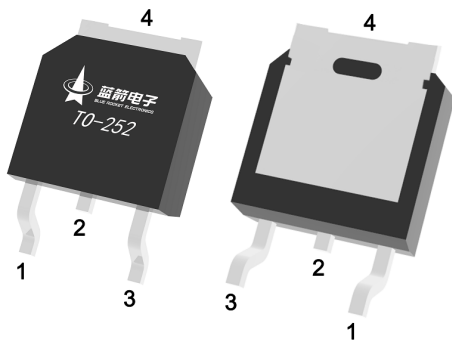

PIN1 : G      PIN 2、4 : D      PIN 3 : S

**印章代码 / Marking**

见印章说明。  
See Marking Instructions.

**极限参数 / Absolute Maximum Ratings(Ta=25°C)**

参数 Parameter	符号 Symbol	数值 Rating	单位 Unit
Drain-Source Voltage	V <sub>DSS</sub>	200	V
Drain Current	I <sub>D</sub> (Tc=25°C)	9	A
Drain Current - Pulsed	I <sub>DM</sub>	36	A
Gate-Source Voltage	V <sub>GS</sub>	±20	V
Single Pulsed Avalanche Energy(L=10mH)	E <sub>AS</sub>	166	mJ
Avalanche Current(L=10mH)	I <sub>AS</sub>	5	A
Power Dissipation	P <sub>D</sub> (Tc=25°C)	46	W
Operating and Storage Temperature Range	T <sub>J</sub> , T <sub>STG</sub>	-55 to 150	°C
Maximum Junction-to-Ambient	R <sub>θJA</sub>	100.3	°C/W
Maximum Junction-to-Case	R <sub>θJC</sub>	2.7	

**电性能参数 / Electrical Characteristics(Ta=25°C)**

参数 Parameter	符号 Symbol	测试条件 Test Conditions	最小值 Min	典型值 Typ	最大值 Max	单位 Unit
Drain-Source Breakdown Voltage	BV <sub>DSS</sub>	V <sub>GS</sub> =0V I <sub>D</sub> =250μA	200			V
Zero Gate Voltage Drain Current	I <sub>DSS</sub>	V <sub>DS</sub> =200V V <sub>GS</sub> =0V			1	μA
Gate-Body Leakage Current Forward	I <sub>GSS</sub>	V <sub>GS</sub> =±20V V <sub>DS</sub> =0V			±100	nA
Gate Threshold Voltage	V <sub>GS(th)</sub>	V <sub>DS</sub> =V <sub>GS</sub> I <sub>D</sub> =250μA	2	3	4	V
Total gate charge	R <sub>DS(on)</sub>	V <sub>GS</sub> =10V I <sub>D</sub> =4.5A		0.35	0.4	Ω
Gate resistance	R <sub>g</sub>	V <sub>GS</sub> =0V f=1MHz V <sub>DS</sub> =0V,		1.7		Ω
Input Capacitance	C <sub>iss</sub>	V <sub>DS</sub> =25V V <sub>GS</sub> =0V f=1MHz		630		pF
Output Capacitance	C <sub>oss</sub>			270		
Reverse Transfer Capacitance	C <sub>rss</sub>			50		
Total Gate Charge	Q <sub>g</sub>	V <sub>GS</sub> =10V, I <sub>G</sub> =1.5mA, V <sub>DS</sub> =160V, I <sub>D</sub> =9A		21	30	nC
Gate Source Charge	Q <sub>gs</sub>			11.2	20	
Gate Drain Charge	Q <sub>gd</sub>			9.5	15	

**电性能参数 / Electrical Characteristics(Ta=25°C)**

参数 Parameter	符号 Symbol	测试条件 Test Conditions	最小值 Min	典型值 Typ	最大值 Max	单位 Unit
Turn-On Delay Time	$t_{d(on)}$	$V_{GS}=10V$ $V_{DS}=90V$ $R_L=9.6\ \Omega$ $R_{GEN}=9.1\ \Omega$		15	32	ns
Turn-On Rise Time	$t_r$			33	53	
Turn-Off Delay Time	$t_{d(off)}$			40	55	
Turn-Off Fall Time	$t_f$			30	45	
Maximum Continuous Drain-Source Diode Forward Current	$I_S$				9	A
Maximum Pulsed Drain-Source Diode Forward Current	$I_{SM}$				36	A
Drain-Source Diode Forward Voltage	$V_{SD}$	$V_{GS} = 0\ V,$ $I_S = 9.0A$			1.2	V
Reverse Recovery Time	$t_{rr}$	$V_{GS} = 0V,$ $I_S = 9.0A,$ $dI_F/dt = 100\ A/\mu s$		455		nS
Reverse Recovery Charge	$Q_{rr}$				3.5	

**电参数曲线图 / Electrical Characteristic Curve**

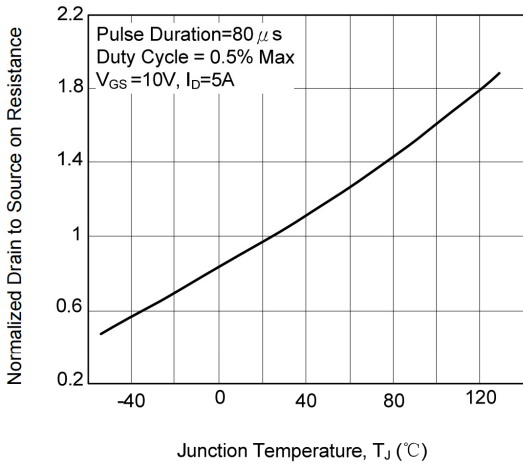

1. Normalized Drain to Source on Resistance vs. Junction Temperature

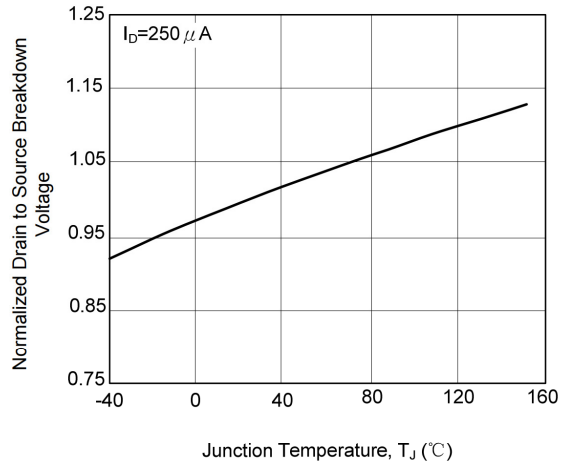

2. Normalized Drain to Source Breakdown Voltage vs. Junction Temperature

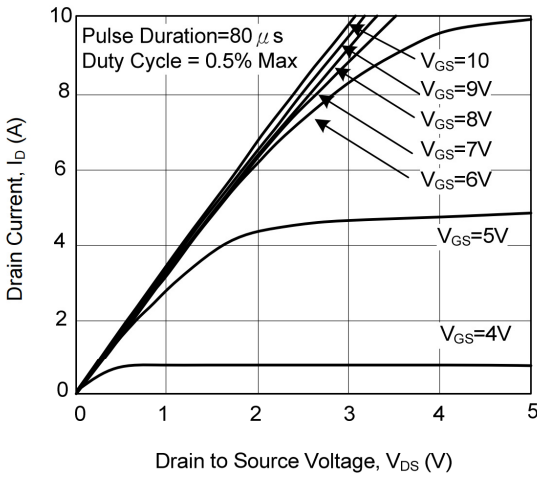

3. Saturation Characteristics

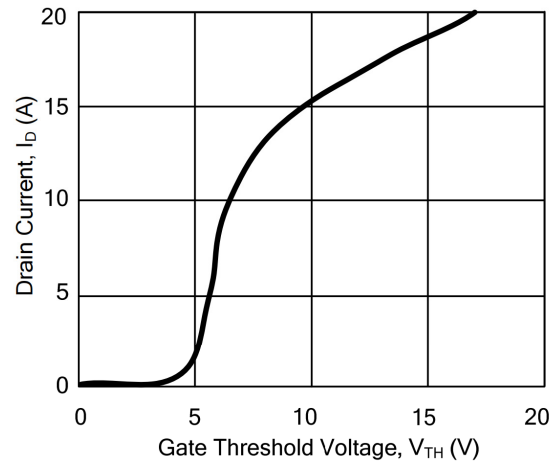

4. Drain Current vs. Gate Threshold Voltage

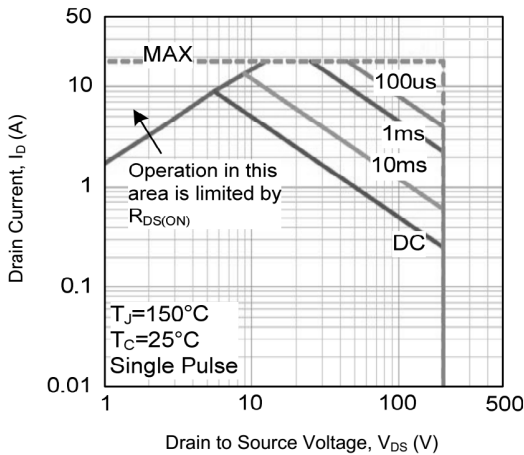

5. Forward Bias Safe Operating Area

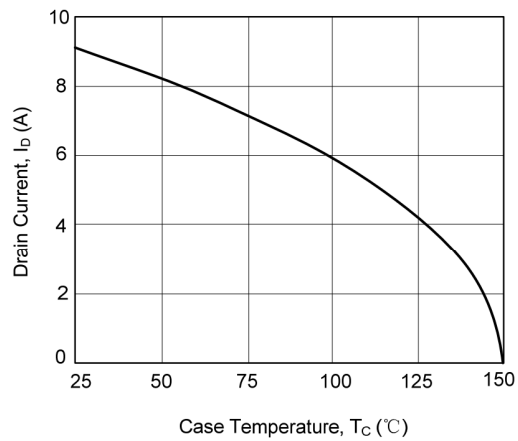

6. Maximum Continuous Drain Current vs. Case Temperature

**外形尺寸图 / Package Dimensions**

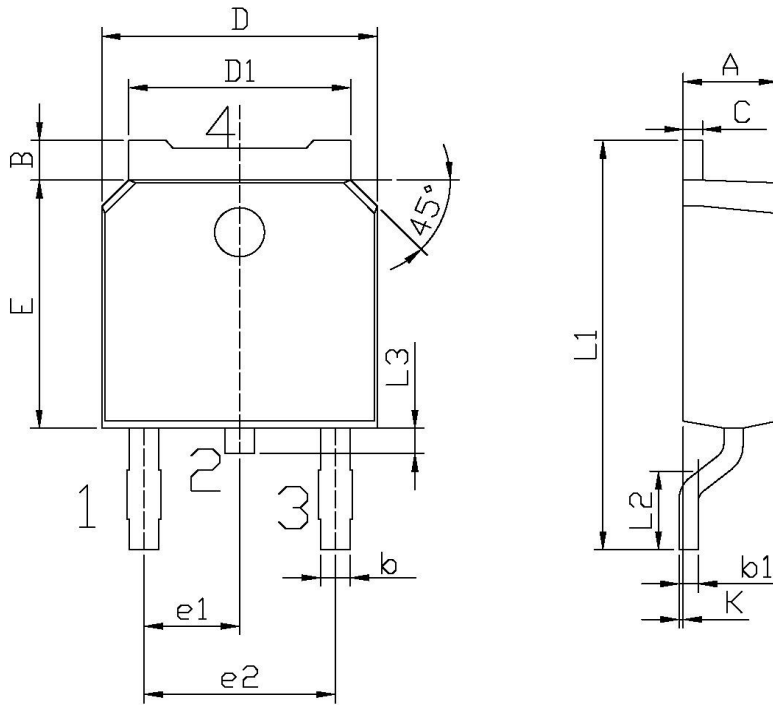

单位: mm

Symbol	Dimensions In Millimeters		Symbol	Dimensions In Millimeters	
	Min	Max		Min	Max
A	2.20	2.40	E	5.95	6.25
B	0.95	1.25	e1	2.24	2.34
b	0.70	0.90	e2	4.43	4.73
b1	0.45	0.55	L1	9.85	10.35
C	0.45	0.55	L2	1.70	2.00
D	6.45	6.75	L3	0.60	0.90
D1	5.10	5.50	K	0.00	0.10

TO-252

**印章说明 / Marking Instructions**

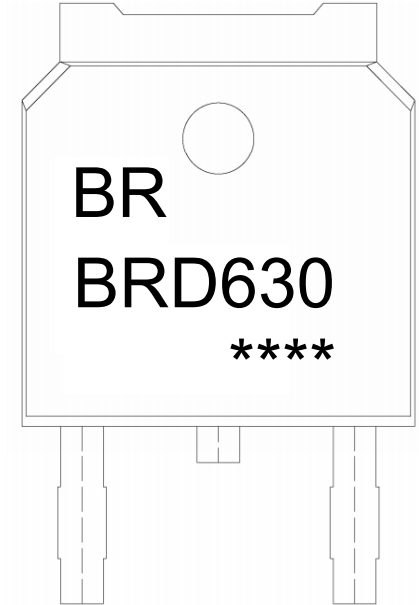

说明：

BR： 为公司代码

BRD630： 为型号代码

\*\*\*\*： 为生产批号代码，随生产批号变化

Note:

BR: Company Code

BRD630: Product Type Code

\*\*\*\*: Lot No. Code, code change with Lot No

**回流焊温度曲线图(无铅) / Temperature Profile for IR Reflow Soldering(Pb-Free)**

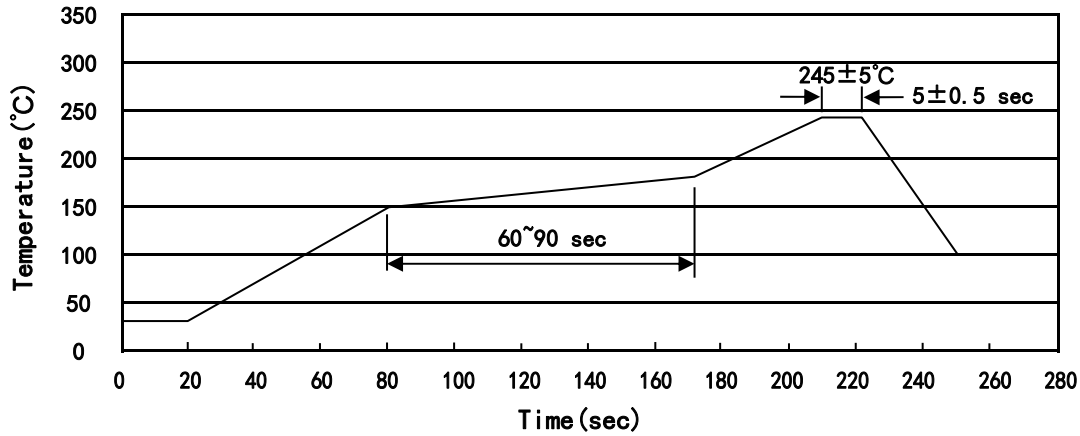

说明：

- 1、预热温度 150~180°C，时间 60~90sec;
- 2、峰值温度 245±5°C，时间持续为 5±0.5sec;
- 3、焊接制程冷却速度为 2~10°C/sec.

Note:

- 1.Preheating:150~180°C, Time:60~90sec.
- 2.Peak Temp.:245±5°C, Duration:5±0.5sec.
3. Cooling Speed: 2~10°C/sec.

**耐焊接热试验条件 / Resistance to Soldering Heat Test Conditions**

温度：260±5°C      时间：10±1 sec.      Temp.:260±5°C      Time:10±1 sec

**包装规格 / Packaging SPEC.**

卷盘包装 / REEL

Package Type 封装形式	Units 包装数量					Dimension 包装尺寸 (unit: mm <sup>3</sup> )		
	Units/Reel 只/卷盘	Reels/Inner Box 卷盘/盒	Units/Inner Box 只/盒	Inner Boxes/Outer Box 盒/箱	Units/Outer Box 只/箱	Reel	Inner Box 盒	Outer Box 箱
TO-252	2,500	2	5,000	6	30,000	13" ×16	360×360×50	380×335×366

套管包装 / TUBE

Package Type 封装形式	Units 包装数量					Dimension 包装尺寸 (unit: mm <sup>3</sup> )		
	Units/Tube 只/套管	Tubes/Inner Box 套管/盒	Units/Inner Box 只/盒	Inner Boxes/Outer Box 盒/箱	Units/Outer Box 只/箱	Tube 套管	Inner Box 盒	Outer Box 箱
TO-251/252	75	48	3,600	5	18,000	526×20.5×5.25	555×164×50	575×290×180

**使用说明 / Notices**